

# Global Quantum Computation: Error Correction and Fault Tolerance

**Jason Twamley**

*Centre for Quantum Computer Technology, Macquarie University, Sydney, Australia*

**Joseph Fitzsimons**

*Department of Materials, Oxford University, UK*

# Contents

- Quick Overview of global quantum computation
- Quick review of Globally Controlled Translationally Invariant quantum computation scheme by JF&JT
- Quick intro in Quantum Error Correction & Fault Tolerance & Concatenation
- Executing QEC globally using our scheme
- How to ensure Fault Tolerance and engineer Concatenation

# Overview of Global QC

- To avoid the use of local addressing and control of quantum information in the performance of algorithms etc.
- Almost all known QC schemes require massive amounts of local addressing, e.g. circuit schemes. one-way schemes, etc.
- Engineering this level of classical and quantum control will be very tough technologically. Might Generate lots of heat/decoherence?
- QUESTION? Do we really need this level of control?
- NO!!!
- One of the earliest designs for a QC from Lloyd: ABCABCABC chain...

# Overview of Global QC

## A Potentially Realizable Quantum Computer

Seth Lloyd **Science (1993)**

Arrays of weakly coupled quantum systems might compute if subjected to a sequence of electromagnetic pulses of well-defined frequency and length. Such pulsed arrays are true quantum computers: Bits can be placed in superpositions of 0 and 1, logical operations take place coherently, and dissipation is required only for error correction. Operated with frequent error correction, such a system functions as a parallel digital computer. Operated in a quantum-mechanically coherent manner, such a device functions as a general-purpose quantum-mechanical micromanipulator, capable of both creating any desired quantum state of the array and transforming that state in any desired way.

**Fig. 1.** Two wires. In (1), data is encoded in the *A* units in a section, and all the *B*'s and *C*'s, except for one unit, are set to 0. Call the unit in which  $C = 1$  the control unit. In (2), the array has been subjected to a series of pulses that realizes a Fredkin gate on each triple *ABC*. The only triple affected is the one in which the control unit sits: Here, the bit of data has been moved to the *B* unit. In (3), the information in the *BC* units has been moved 3 triples to the right by the information-swapping process given in the text. In (4), the operation of a Fredkin gate on all triples has swapped  $x_1$  with  $x_4$ ; all other triples are unchanged. In (5), the information in the *BC* units has been moved back three triples to the left. In (6), the operation of a Fredkin gate on all triples has restored  $x_4$  to the *A* unit in the triple. The first three configurations show the action of the first wire, moving  $x_1$  adjacent to  $x_4$ ; the second three configurations show the action of the second wire, moving  $x_4$  back to  $x_1$ 's old place. The set of pulses transporting the data is independent of the data being transported.

	<i>A</i>	<i>B</i>	<i>C</i>	<i>A</i>	<i>B</i>	<i>C</i>	<i>A</i>	<i>B</i>	<i>C</i>	<i>A</i>	<i>B</i>	<i>C</i>
1	$x_1$	0	1	$x_2$	0	0	$x_3$	0	0	$x_4$	0	0
2	0	$x_1$	1	$x_2$	0	0	$x_3$	0	0	$x_4$	0	0
3	0	0	0	$x_2$	0	0	$x_3$	0	0	$x_4$	$x_1$	1
4	0	0	0	$x_2$	0	0	$x_3$	0	0	$x_1$	$x_4$	1
5	0	$x_4$	1	$x_2$	0	0	$x_3$	0	0	$x_1$	0	0
6	$x_4$	0	1	$x_2$	0	0	$x_3$	0	0	$x_1$	0	0

ABCABCABC  
3 Component  
Chain  
Updated Globally

## Next Design: Simon Benjamin, (Oxford), in 2000

PHYSICAL REVIEW A, VOLUME 61, 020301(R)

### **Schemes for parallel quantum computation without local control of qubits**

S. C. Benjamin\*

*Center for Quantum Computation, Clarendon Laboratory, University of Oxford OXI 3PU, United Kingdom*  
(Received 29 March 1999; revised manuscript received 20 September 1999; published 18 January 2000)

Typical quantum computing schemes require transformations (gates) to be targeted at specific elements (qubits). In many physical systems, direct targeting is difficult to achieve; an alternative is to encode local gates into globally applied transformations. Here we demonstrate the minimum physical requirements for such an approach: a one-dimensional array composed of two alternating “types” of two-state system. Each system need be sensitive only to the *net* state of its nearest neighbors, i.e. the number in state “ $\uparrow$ ” minus the number in “ $\downarrow$ .” Additionally, we show that all such arrays can perform quite general *parallel* operations. A broad range of physical systems and interactions is suitable: we highlight two examples.

# Overview of Global QC



Logical encoding  
of qubits

Special "Classical"  
Control Pattern

Need to execute control on all A sites where control is based on combined state of both B neighbors

## Single Qubit Gate

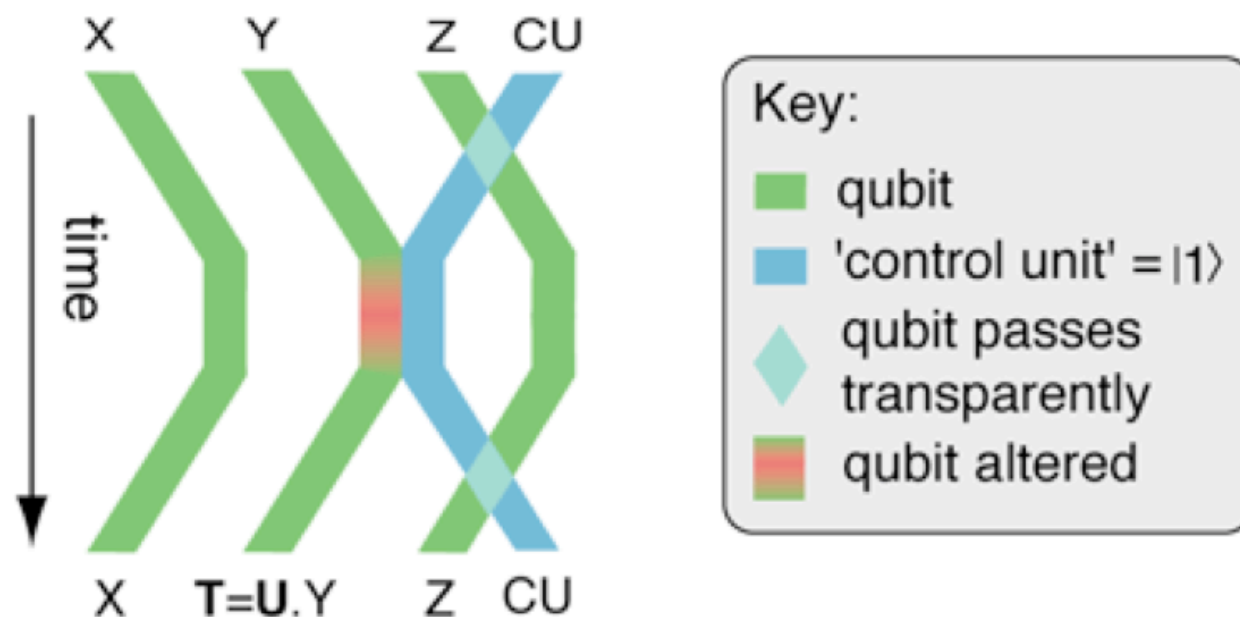

# Overview of Global QC

## 2-Qubit Gate

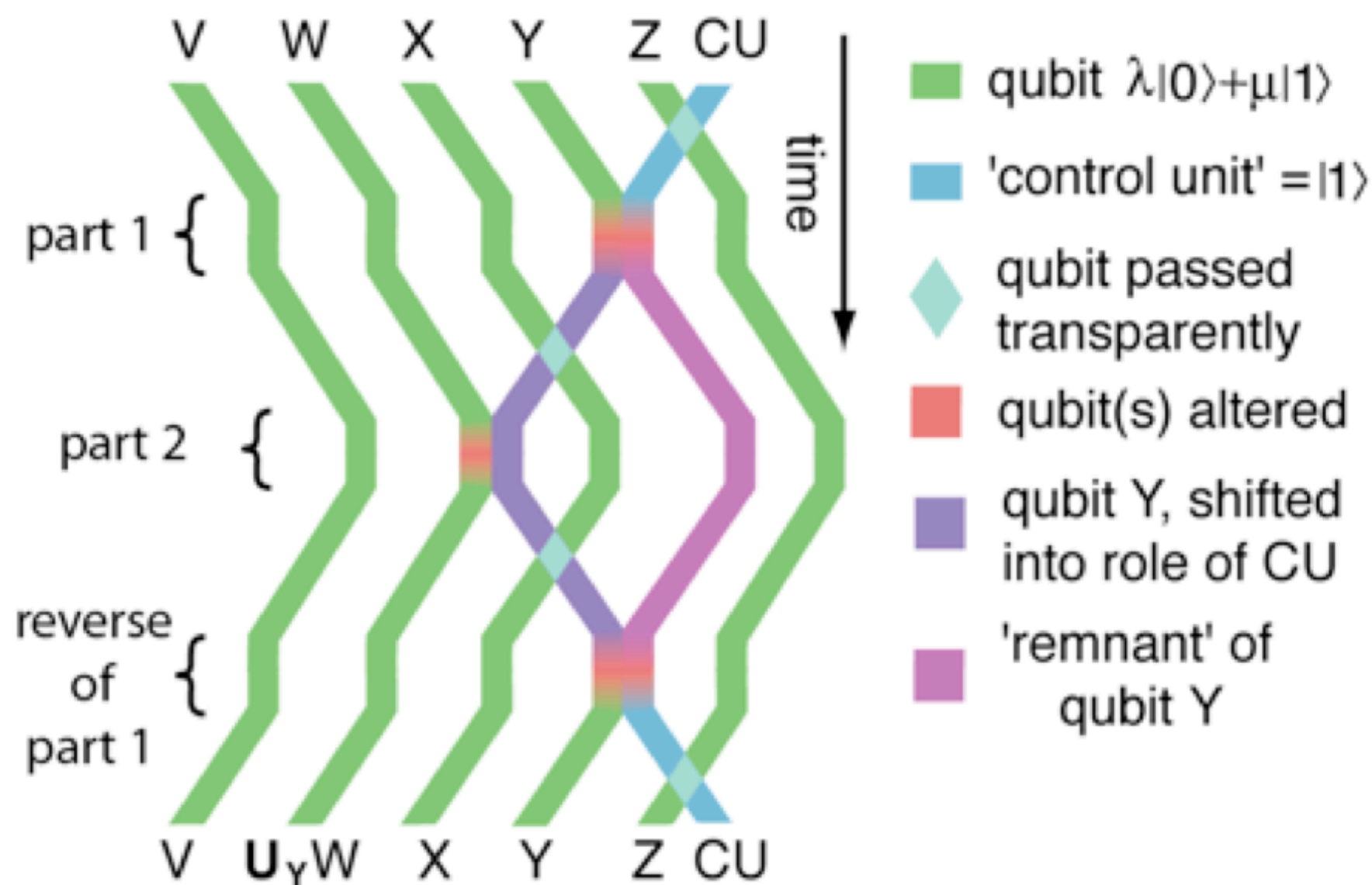



# Overview of Global QC

## Variants

ABABAB + collectively switched Heisenberg interaction  
Given the ability to switch on and off various interactions between A and B qubits, S. C. Benjamin, PRL 88, 017904 (2002).

Not as easy to engineer physically? Again uses a Control Pattern to steer control to particular gates.

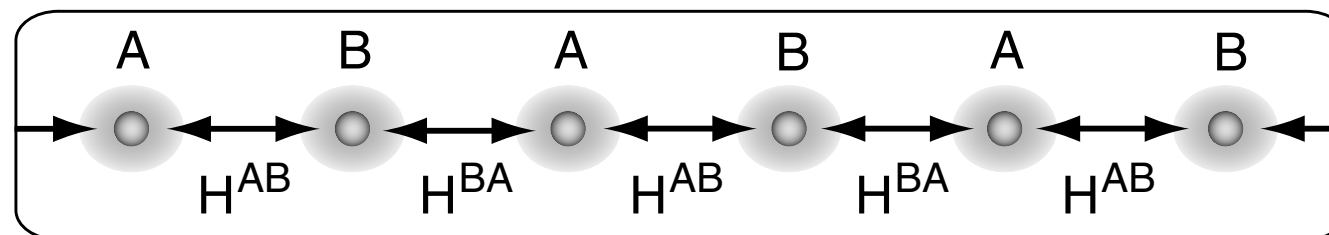



# Overview of Global QC

## Work to simulate arbitrary quantum dynamics and computation using a generic entangling Hamiltonian

Some speculation whether the result could hold in a quantum cellular automata design, i.e. the local unitaries are applied homogeneously at once  
- no results

PHYSICAL REVIEW A, VOLUME 65, 040301(R)

## Universal quantum computation and simulation using any entangling Hamiltonian and local unitaries

Jennifer L. Dodd, Michael A. Nielsen, Michael J. Bremner, and Robert T. Thew

*Centre for Quantum Computer Technology, Department of Physics, University of Queensland, Queensland 4072, Australia*

(Received 15 June 2001; published 4 April 2002)

What interactions are sufficient to simulate *arbitrary* quantum dynamics in a composite quantum system? We provide an *efficient* algorithm to simulate any desired two-body Hamiltonian evolution using any fixed two-body entangling  $n$ -qubit Hamiltonian and local unitary operations. It follows that universal quantum computation can be performed using *any* entangling interaction and local unitary operations.

# Overview of Global QC

Work to examine the class of Hamiltonian that can be simulated by using inhomogeneous and homogeneously applied local unitaries and some translationally invariant inter-qubit interaction

Simulation of quantum dynamics with quantum optical systems

E. Jané,<sup>1</sup> G. Vidal,<sup>2</sup> W. Dür,<sup>3</sup> P. Zoller,<sup>4</sup> and J.I. Cirac<sup>5</sup>

<sup>1</sup>*Departament d'Estructura i Constituents de la Matèria,  
Universitat de Barcelona, Diagonal 647, E-08028 Barcelona, Spain*

<sup>2</sup>*Institute for Quantum Information, California Institute for Technology, Pasadena, CA 91125 USA*

<sup>3</sup>*Sektion Physik, Ludwig-Maximilians-Universität München, Theresienstr. 37, D-80333 München, Germany*

<sup>4</sup>*Institut für Theoretische Physik, Universität Innsbruck, A-6020 Innsbruck, Austria*

<sup>5</sup>*Max-Planck Institut für Quantenoptik, Hans-Kopfermann Str. 1, D-85748 Garching, Germany*

(Dated: 25th May 2006)

We propose the use of quantum optical systems to perform universal simulation of quantum dynamics. Two specific implementations that require present technology are put forward for illustrative purposes. The first scheme consists of neutral atoms stored in optical lattices, while the second scheme consists of ions stored in an array of micro-traps. Each atom (ion) supports a two-level system, on which local unitary operations can be performed through a laser beam. A raw interaction between neighboring two-level systems is achieved by conditionally displacing the corresponding atoms (ions). Then, average Hamiltonian techniques are used to achieve evolutions in time according to a large class of Hamiltonians.

quant-ph/0207011

# Overview of Global QC

Universal QC can be efficiently simulated via translationally invariant requires 1-qubit and several types of 2 qubit global gates.

PHYSICAL REVIEW A 72, 022339 (2005)

## Quantum computing on lattices using global two-qubit gates

G. Ivanyos\*

*Computer and Automation Research Institute, Hungarian Academy of Sciences, H-1518 Budapest, P.O. Box 63., Hungary*

S. Massar†

*Laboratoire d'Information Quantique and QUIC, C.P. 165/59, Av. F. D. Roosevelt 50, B-1050 Bruxelles, Belgium*

A. B. Nagy‡

*Budapest University of Technology and Economics, H-1521 Budapest, P.O. Box 91., Hungary*

(Received 7 March 2005; revised manuscript received 8 June 2005; published 29 August 2005)

We study the computation power of lattices composed of two-dimensional systems (qubits) on which translationally invariant global two-qubit gates can be performed. We show that if a specific set of six global two qubit gates can be performed and if the initial state of the lattice can be suitably chosen, then a quantum computer can be efficiently simulated.

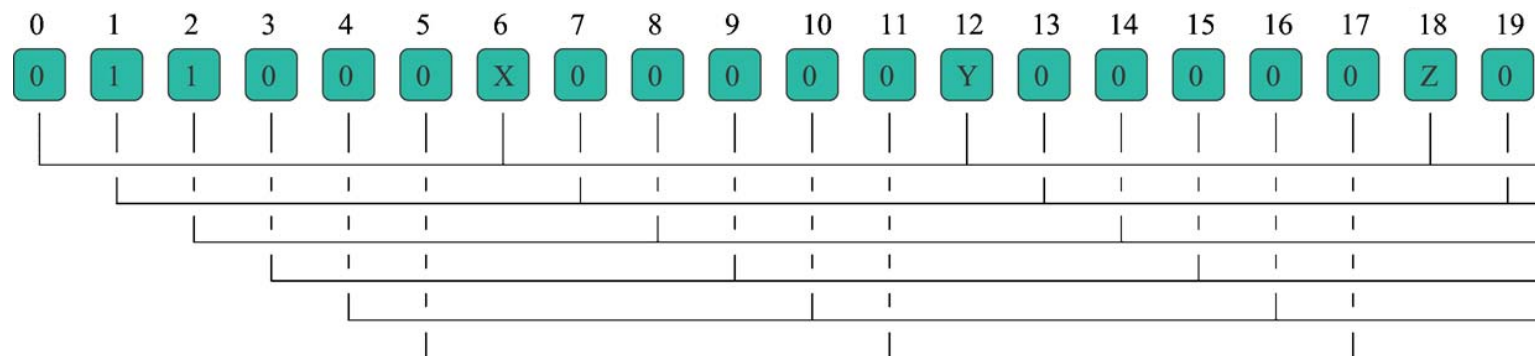

# Overview of Global QC

To show universal quantum computation via a **homogenous** chain and translation-invariant operations

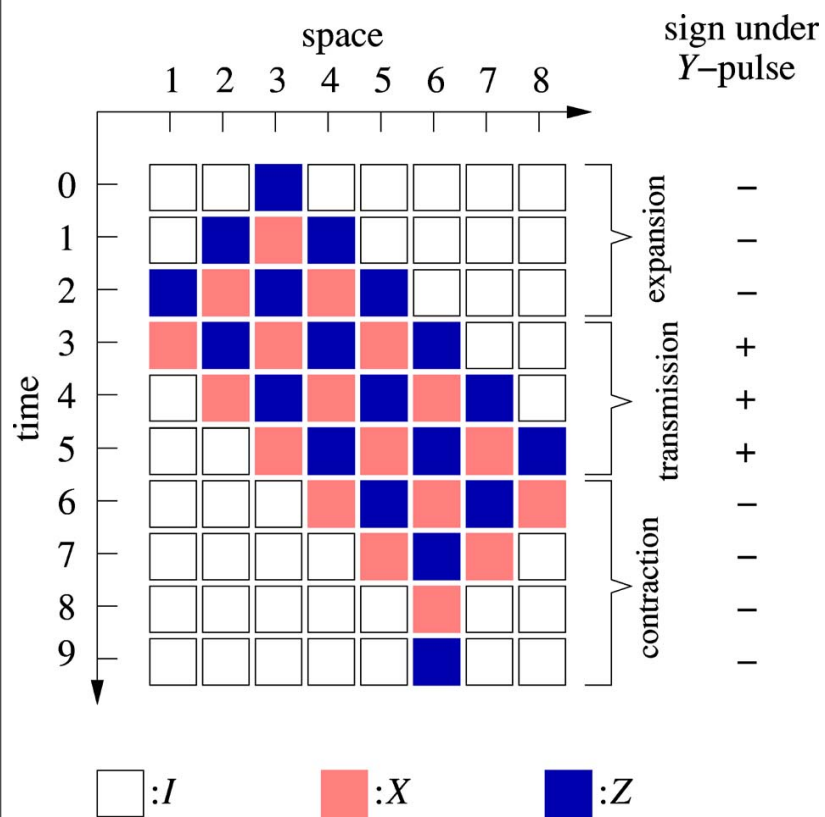

PHYSICAL REVIEW A **72**, 052301 (2005)

## Quantum computation via translation-invariant operations on a chain of qubits

Robert Raussendorf

*California Institute of Technology, Institute for Quantum Information, Pasadena, California 91125, USA*

(Received 17 June 2005; published 1 November 2005)

A scheme of universal quantum computation is described that does not require local control. All the required operations, an Ising-type interaction and spatially uniform simultaneous one-qubit gates, are translation invariant.

## Work to show universal quantum computation via a homogenous chain and translation-invariant operations

Requires qu5its and nearest neighbor interactions

PHYSICAL REVIEW A **73**, 012324 (2006)

### Reversible universal quantum computation within translation-invariant systems

K. G. H. Vollbrecht and J. I. Cirac

*Max-Planck Institut für Quantenoptik, Hans-Kopfermann-Strasse 1, Garching, D-85748, Germany*

(Received 29 March 2005; published 18 January 2006)

We show how to perform reversible universal quantum computation on a translationally invariant pure state, using only global operations based on next-neighbor interactions. We do not need to break the translational symmetry of the state at any time during the computation. Since the proposed scheme fulfills the locality condition of a quantum cellular automata, we present a reversible quantum cellular automaton capable of universal quantum computation.

## Work to show universal quantum computation via a homogenous chain and translation-invariant operations

PRL 97, 090502 (2006)

PHYSICAL REVIEW LETTERS

week ending  
1 SEPTEMBER 2006

### Globally Controlled Quantum Wires for Perfect Qubit Transport, Mirroring, and Computing

Joseph Fitzsimons<sup>1,\*</sup> and Jason Twamley<sup>2,†</sup>

<sup>1</sup>*Department of Materials, Oxford University, Oxford, United Kingdom*

<sup>2</sup>*Centre for Quantum Computer Technology, Macquarie University, Sydney, NSW 2109, Australia*

(Received 9 February 2006; published 1 September 2006)

We describe a new design for a  $q$  wire with perfect transmission using a uniformly coupled Ising spin chain subject to global pulses. In addition to allowing for the perfect transport of single qubits, the design also yields the perfect “mirroring” of multiply encoded qubits within the wire. We further utilize this global-pulse generated perfect mirror operation as a “clock cycle” to perform universal quantum computation on these multiply encoded qubits where the interior of the  $q$  wire serves as the quantum memory while the  $q$ -wire ends perform one- and two-qubit gates.

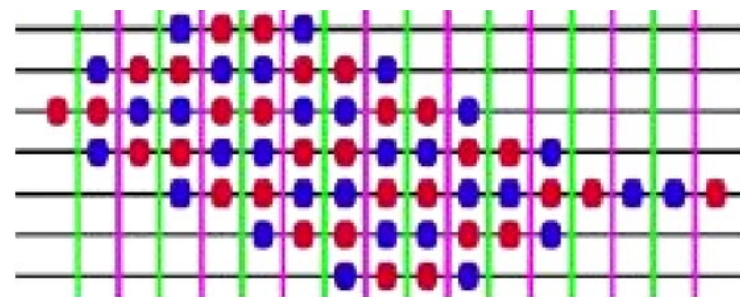



# Overview of Global QC

## Intriguing use of Quantum Cellular Automata to increase signal strength in SS NMR QC

PRL 97, 100501 (2006)

PHYSICAL REVIEW LETTERS

week ending  
8 SEPTEMBER 2006

### Single Spin Measurement Using Cellular Automata Techniques

Carlos A. Pérez-Delgado,<sup>1</sup> Michele Mosca,<sup>1,2</sup> Paola Cappellaro,<sup>3</sup> and David G. Cory<sup>3</sup>

<sup>1</sup>*Institute for Quantum Computing, University of Waterloo, Waterloo, ON N2L 3G1, Canada*

<sup>2</sup>*Perimeter Institute for Theoretical Physics, Waterloo, ON N2J 2W9, Canada*

<sup>3</sup>*Department of Nuclear Science and Engineering, Massachusetts Institute of Technology, Cambridge, Massachusetts 02139, USA*

(Received 3 January 2006; revised manuscript received 2 June 2006; published 7 September 2006)

We analyze a conceptual approach to single-spin measurement. The method uses techniques from the theory of quantum cellular automata to correlate a large number of ancillary spins to the one to be measured. It has the distinct advantage of being efficient: under ideal conditions, it requires the application of only  $O(\sqrt[3]{N})$  steps (each requiring a constant number of rf pulses) to create a system of  $N$  correlated spins. Numerical simulations suggest that it is also, to a certain extent, robust against pulse errors, and imperfect initial polarization of the ancilla spin system.

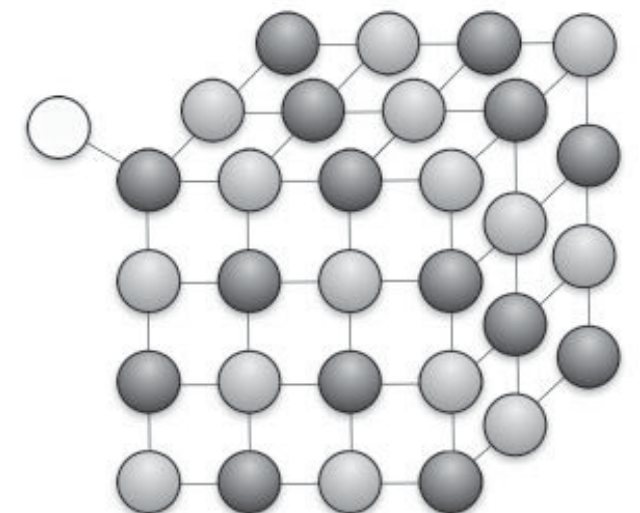



# F&T Scheme

## Goal:

Perfect quantum state transfer in a spin chain

Only global addressing of intermediate qubits

## Motivation:

Spin chains can already be realised in many systems

Using global control overcomes many addressability concerns

Spins at ends of chain have a different energy level structure since they have only one neighbour.

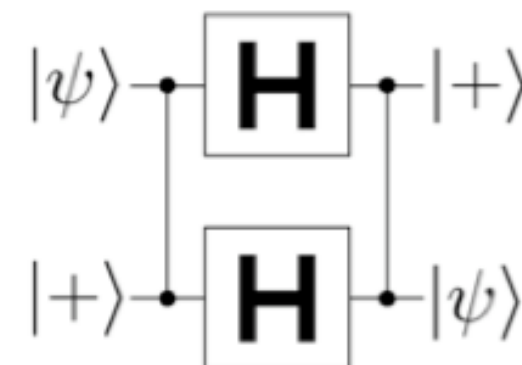
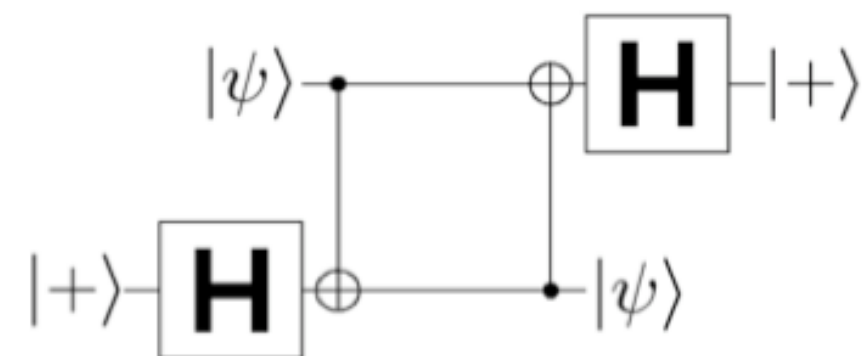
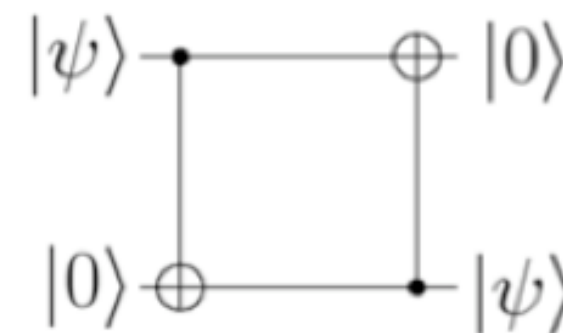
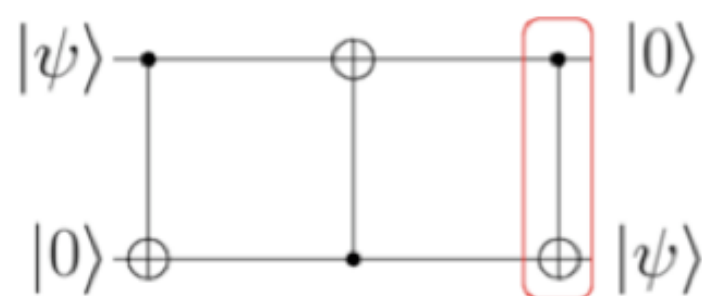
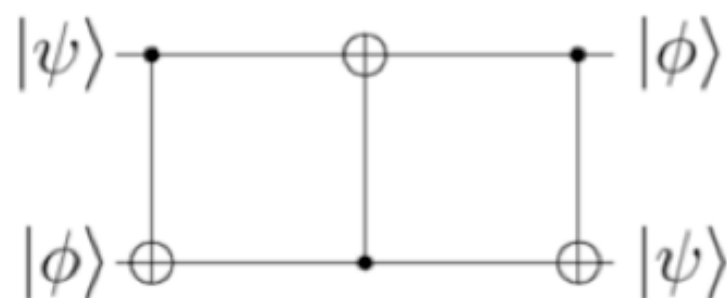

# F&T Scheme

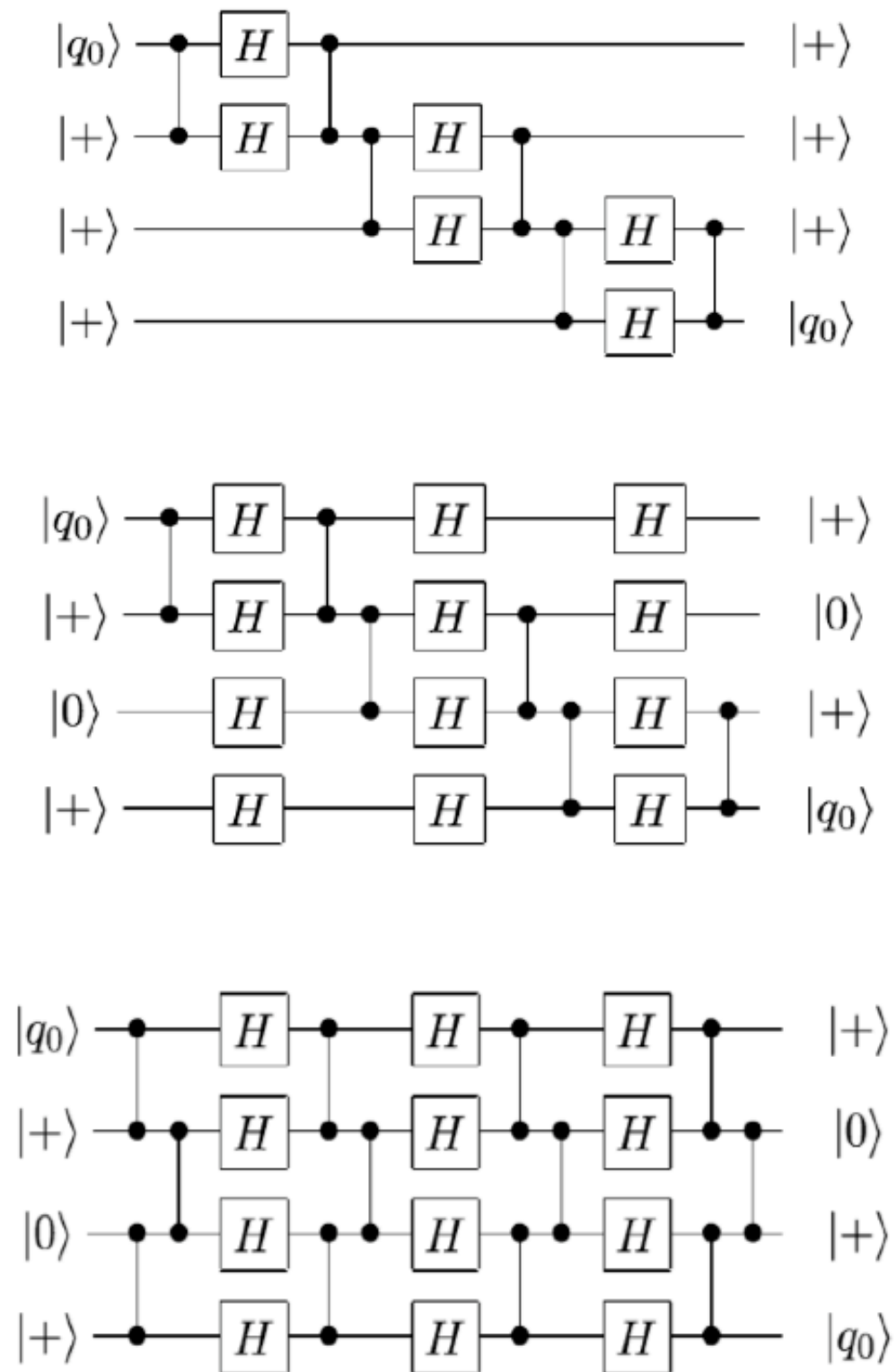
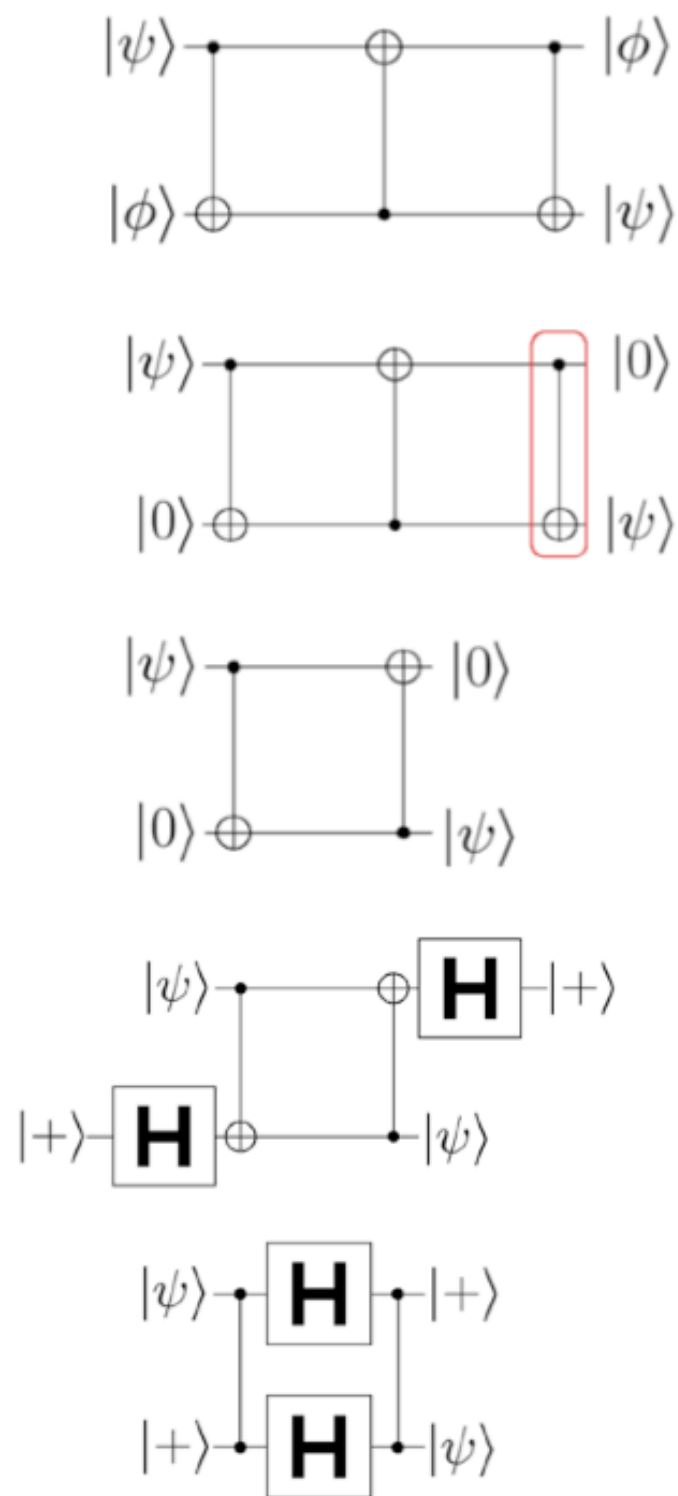

## How to make Global Gates?

$$S = \prod_a U_{CZ}^{(a,a+1)} = \prod_a \frac{1}{2} (I + \sigma_z^{(a)} + \sigma_z^{(a+1)} - \sigma_z^{(a)} \sigma_z^{(a+1)})$$

$$S = \underbrace{\exp\left(+i\frac{\pi}{4}(\sigma_z^{(1)} + \sigma_z^{(N)})\right)}_{\text{green}} \underbrace{\exp\left(-i\frac{\pi}{4} \sum_a \sigma_z^{(a)} \sigma_z^{(a+1)}\right)}_{\text{red}} \times \underbrace{\prod_a \exp\left(-i\frac{\pi}{2} \sigma_z^{(a)}\right)}_{\text{blue}}$$

which contains terms corresponding to an **Ising interaction** between neighbours, a  **$-\pi/2$  Z rotation on all spins** and a  **$\pi/4$  Z rotation on the spins at either end of the chain.**

Global Hadamard 1 qubit gates ok

## Qubit Transfer

Any pure state of a qubit  $a$  can be written as

$$|\Psi_a\rangle = \alpha_a|0\rangle + \beta_a|1\rangle = (\alpha_a + \beta_a\sigma_x^{(a)})|0\rangle$$

So, for any operator  $M$ ,

$$M|\Psi_a\rangle = [M(\alpha_a + \beta_a\sigma_x^{(a)})]|0\rangle = \alpha_a M|0\rangle + \beta_a M\sigma_x^{(a)}|1\rangle$$

The initial state for the spin chain is:

$$|\phi\rangle = |0\rangle \otimes |+\rangle \otimes |0\rangle \otimes |+\rangle \otimes |0\rangle \otimes |+\rangle \otimes \dots \otimes |0\rangle$$

This satisfies  $S|\phi\rangle = |\phi\rangle$  and  $SH|\phi\rangle = H|\phi\rangle$

So for any  $|\psi_a\rangle = (\alpha_a + \beta_a\sigma_x^{(a)})|\phi\rangle$

$$(HS)^m|\psi\rangle = \alpha_a H^m|\phi\rangle + \beta_a (HS)^m\sigma_x^{(a)}|\phi\rangle$$

## Rules for commuting ops thru gates

$$S \sigma_z^{(a)} = \sigma_z^{(a)} S$$

$$S \sigma_x^{(0)} = \sigma_x^{(0)} \sigma_z^{(1)} S$$

$$S \sigma_x^{(N)} = \sigma_z^{(N-1)} \sigma_x^{(N)} S$$

$$S \sigma_x^{(a)} = \sigma_z^{(a-1)} \sigma_x^{(a)} \sigma_z^{(a+1)} S$$

$$H \sigma_z^{(a)} = \sigma_x^{(a)} H$$

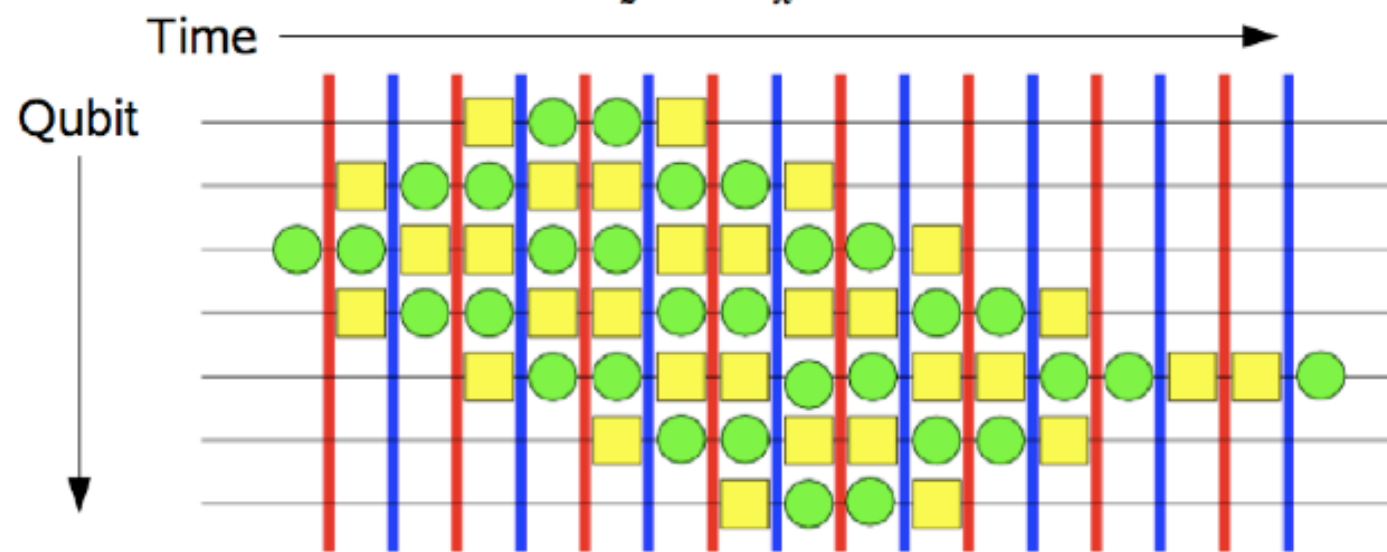

N. Khaneja, S J Glaser Efficient transfer of coherence through Ising Spin Chain,  
Phys Rev A 66, 060301 (2002)

Legend



X Gate



Z Gate



C-Z between all neighbours



Hadamard on every qubit

## Perfect Quantum Mirror Transport

$$(HS)^{N+1} \sigma_x^{(a)} = \sigma_x^{(N-a)} (HS)^{N+1}$$

$$(HS)^{N+1} \sigma_z^{(a)} = \sigma_z^{(N-a)} (HS)^{N+1}$$

$$(HS)^{N+1} (\alpha_a + \beta_a \sigma_z^{(a)}) |\phi\rangle = (\alpha_a + \beta \sigma_z^{(N-a)}) |\psi\rangle$$

$$(HS)^{N+1} |\psi_a\rangle = (\alpha_a + \beta \sigma_x^{(N-a)}) |\psi\rangle$$



# F&T Scheme

## (Im)Perfect Quantum Mirror - NMR QC

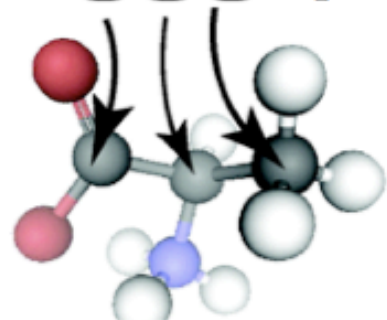

Joseph Fitzsimons, Li Xiao, Simon C. Benjamin, Jonathan A. Jones, quant-ph/606118

Iterations of (H CZ) Sub-figure

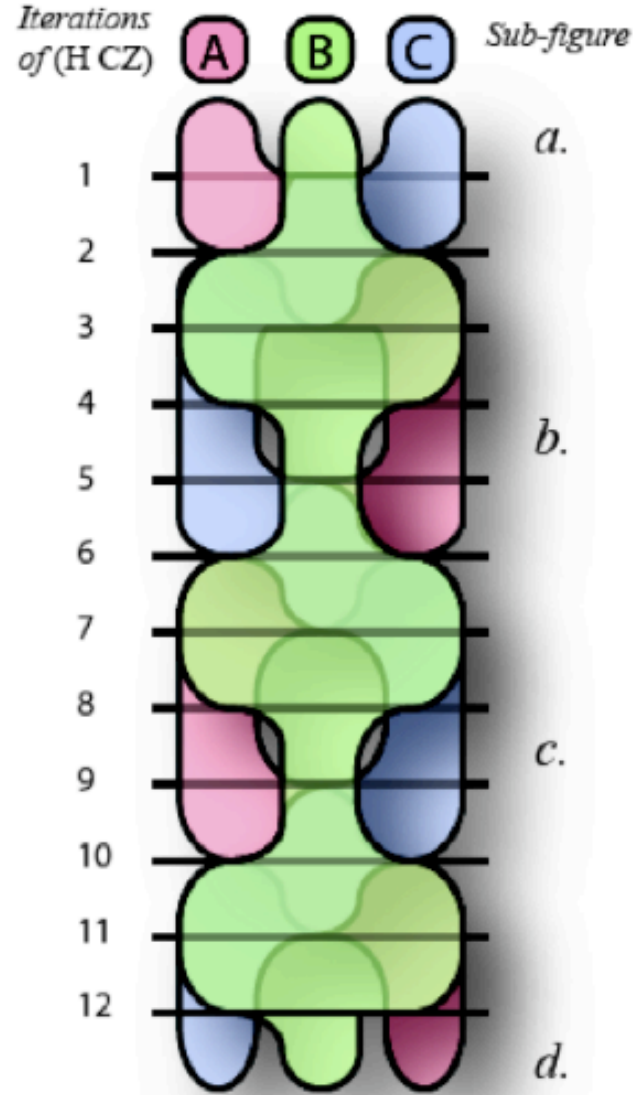

a.

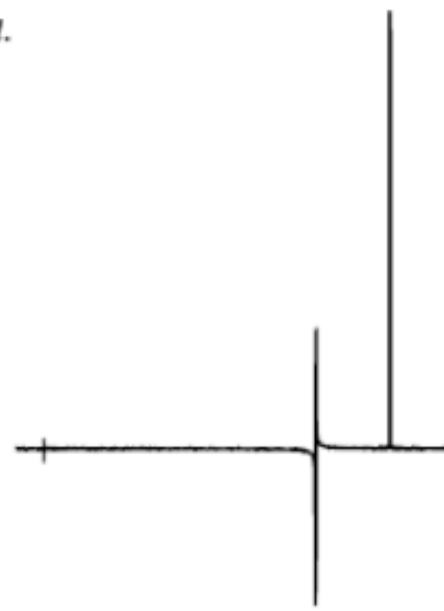

b.

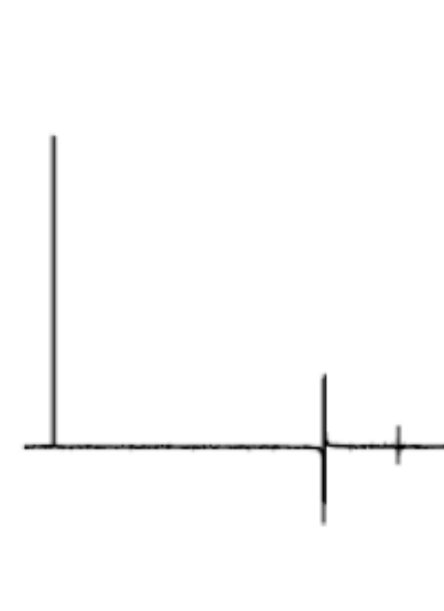

c.

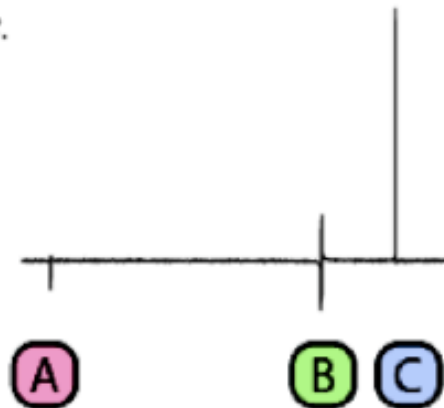

d.

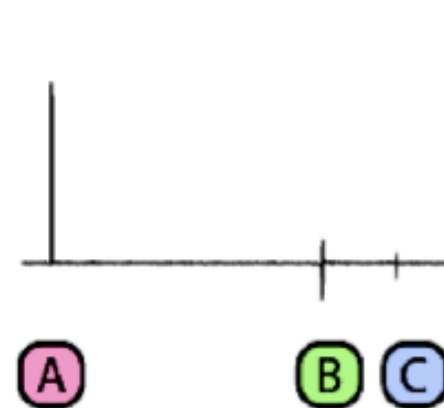



## Computation?

To build upon this scheme, to allow single qubit operations to be performed, it is necessary to separate the logical qubits, adding a  $|+\rangle$  state between each. So

$$|\psi\rangle = |\psi_0\rangle \otimes |+\rangle \otimes |\psi_1\rangle \otimes |+\rangle \otimes |\psi_2\rangle \otimes |+\rangle \otimes \dots \otimes |\psi_N\rangle$$

This ensures that the state of the physical qubit, at a given end, is only affected by one logical qubit.

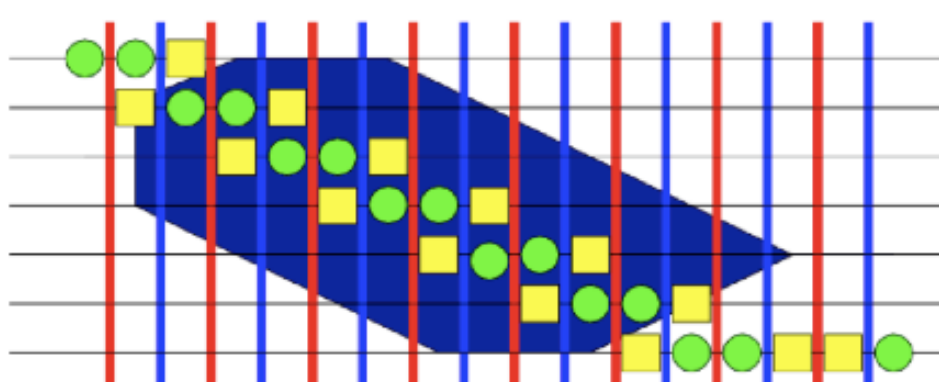
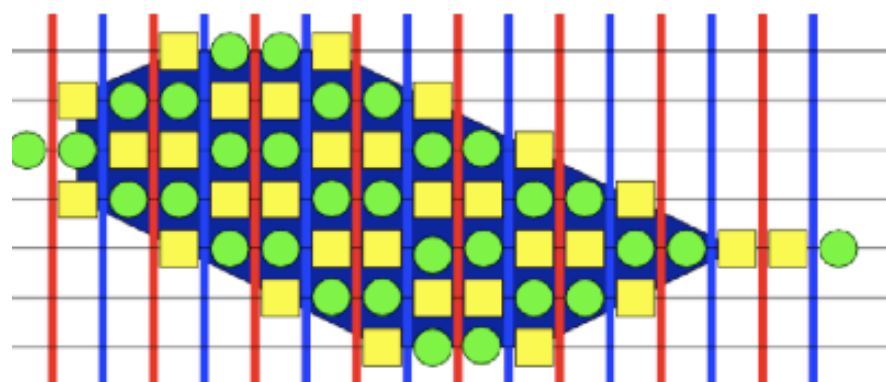
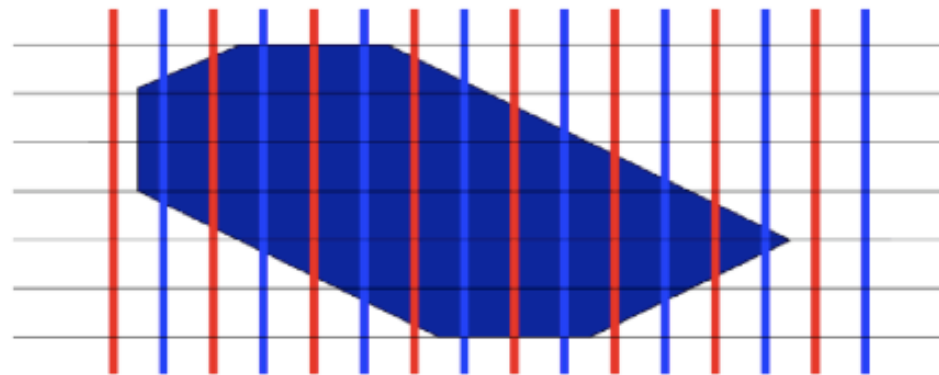
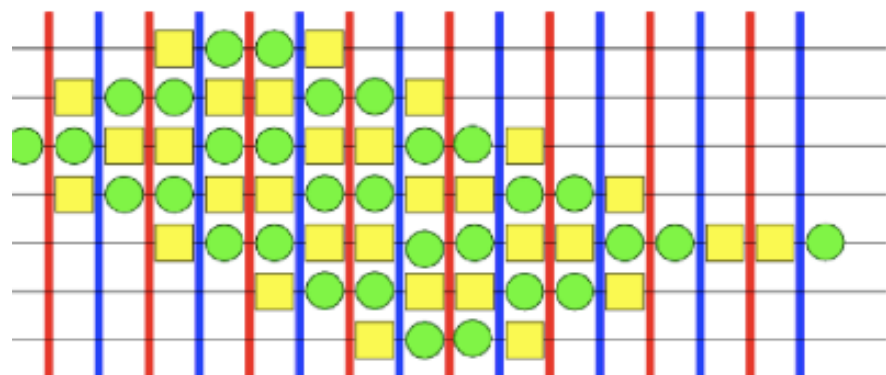

## 1 Qubit Gates?

- Wait for qubit pattern to hit an end and then apply op  $R_z^{end}(\theta)$

$$\overline{H} \cdot \overline{CZ}^2 [a_5|0\rangle_5 + b_5|1\rangle_5] \longrightarrow [a_5\mathbb{I} + b_5\sigma_x^{(3)}\sigma_z^{(4)}\sigma_x^{(5)}\sigma_z^{(6)}\sigma_x^{(7)}]$$

$$\longrightarrow [a_5\mathbb{I} + e^{i\theta}b_5\sigma_x^{(3)}\sigma_z^{(4)}\sigma_x^{(5)}\sigma_z^{(6)}\sigma_x^{(7)}]$$

- Buffer '+'s, end patterns have no overlap
- $U^{(a)}(\alpha, \beta, \gamma) \equiv R_z(\alpha)R_y(\beta)R_z(\gamma)$
- 1st cycle:

$$R_z(\gamma)$$

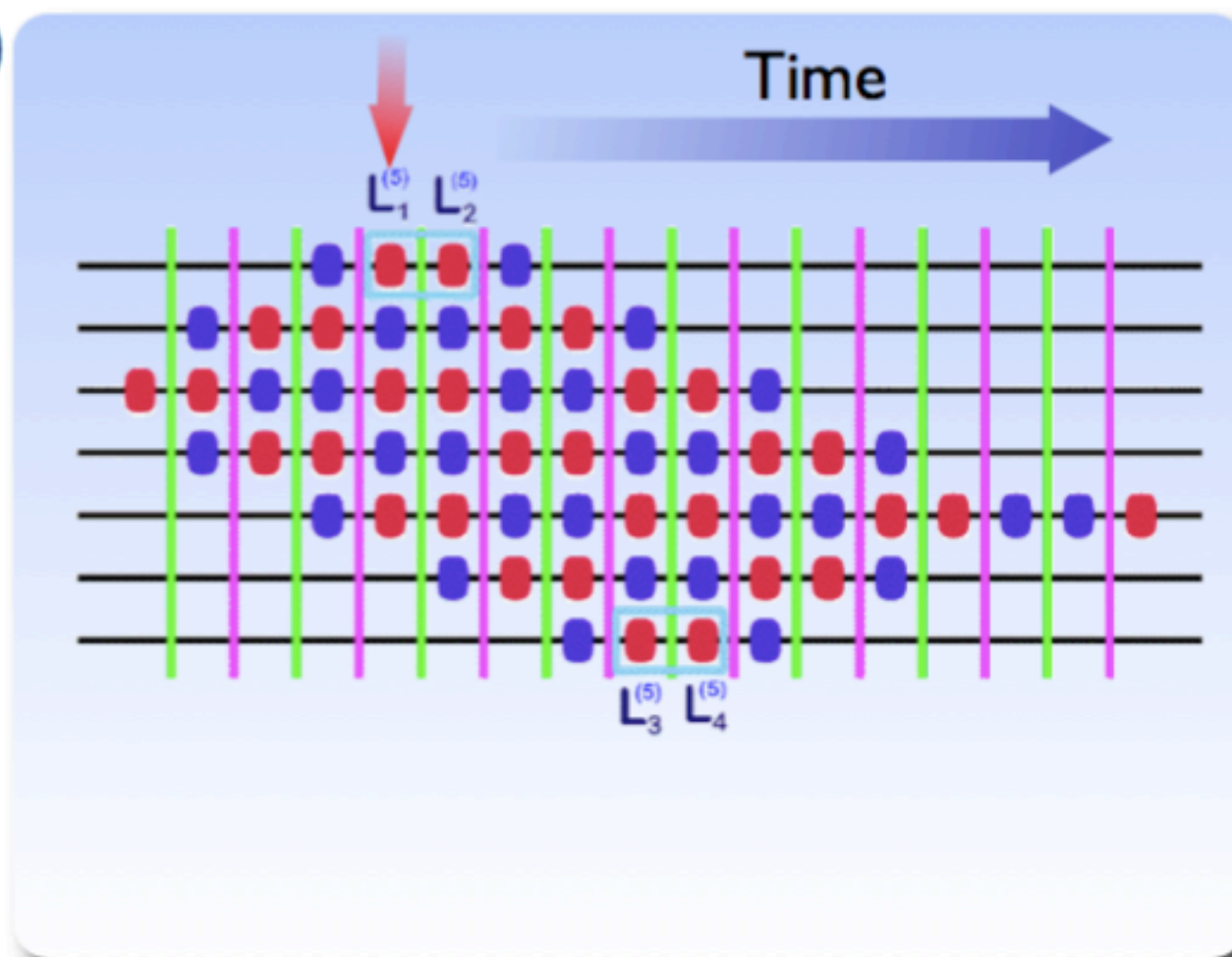

# F&T Scheme

- Wait for qubit pattern to hit an end and then apply op  $R_z^{end}(\theta)$

$$(\overline{H} \cdot \overline{CZ})^2 [a_5|0\rangle_5 + b_5|1\rangle_5] \xrightarrow{\quad} [a_5\mathbb{I} + b_5\sigma_x^{(3)}\sigma_z^{(4)}\sigma_x^{(5)}\sigma_z^{(6)}\sigma_x^{(7)}] \xrightarrow{\quad} [a_5\mathbb{I} + e^{i\theta}b_5\sigma_x^{(3)}\sigma_z^{(4)}\sigma_x^{(5)}\sigma_z^{(6)}\sigma_x^{(7)}]$$

- Buffer +’s, end patterns have no overlap

- $U^{(a)}(\alpha, \beta, \gamma) \equiv R_z(\alpha)R_y(\beta)R_z(\gamma)$

- 2nd Cycle:

$$R_x^{(a)}(\pi/2)R_z(\beta)R_x^{(a)}(\pi/2)R_z(\gamma)$$

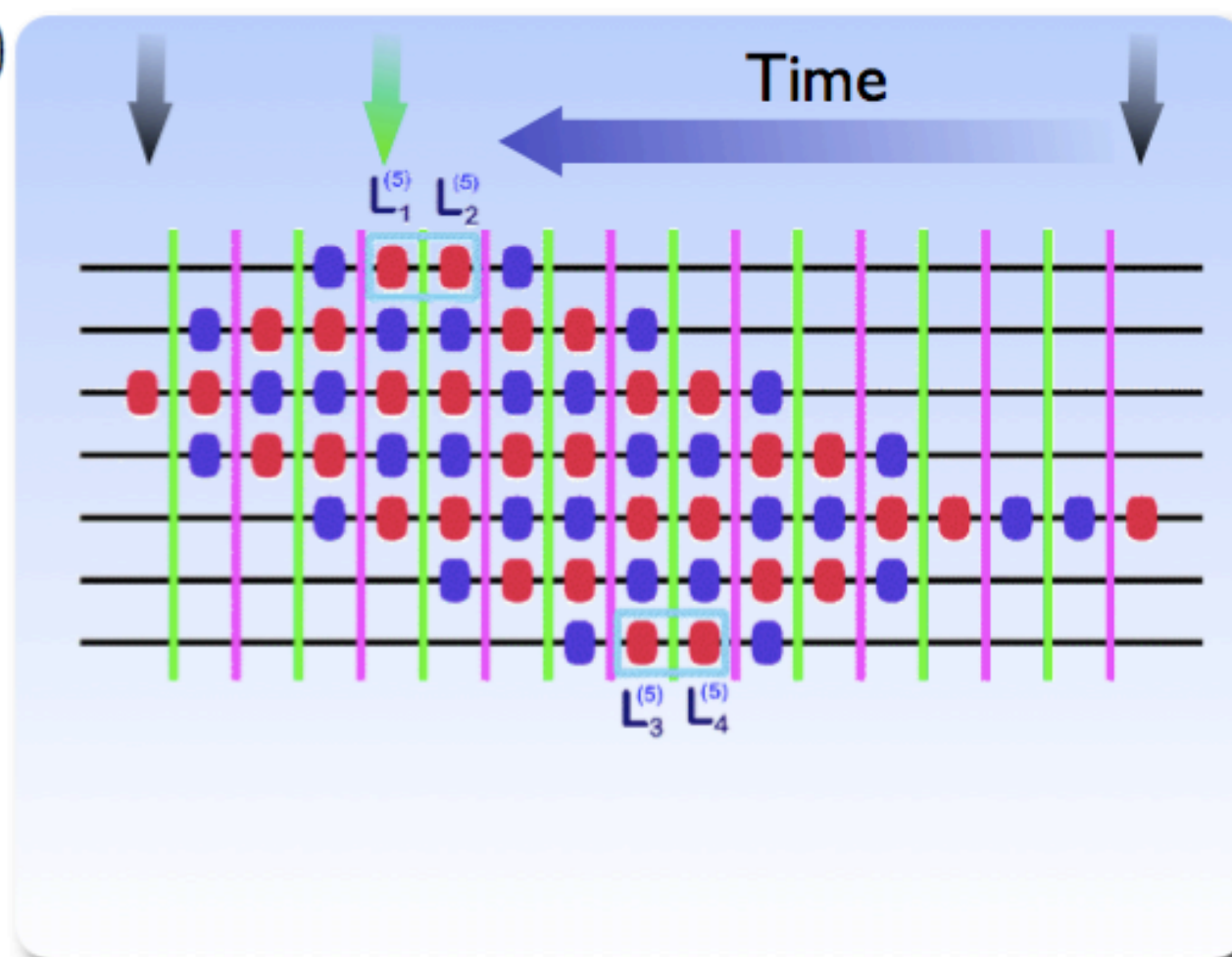



# F&T Scheme

- Wait for qubit pattern to hit an end and then apply op  $R_z^{end}(\theta)$

$$(\overline{H} \cdot \overline{CZ})^2 [a_5|0\rangle_5 + b_5|1\rangle_5] \longrightarrow [a_5\mathbb{I} + b_5\sigma_x^{(3)}\sigma_z^{(4)}\sigma_x^{(5)}\sigma_z^{(6)}\sigma_x^{(7)}]$$

$$\longrightarrow [a_5\mathbb{I} + e^{i\theta}b_5\sigma_x^{(3)}\sigma_z^{(4)}\sigma_x^{(5)}\sigma_z^{(6)}\sigma_x^{(7)}]$$

- Buffer +’s, end patterns have no overlap
- $U^{(a)}(\alpha, \beta, \gamma) \equiv R_z(\alpha)R_y(\beta)R_z(\gamma)$
- 2nd Cycle:

$$R_y(\beta)R_z(\gamma)$$

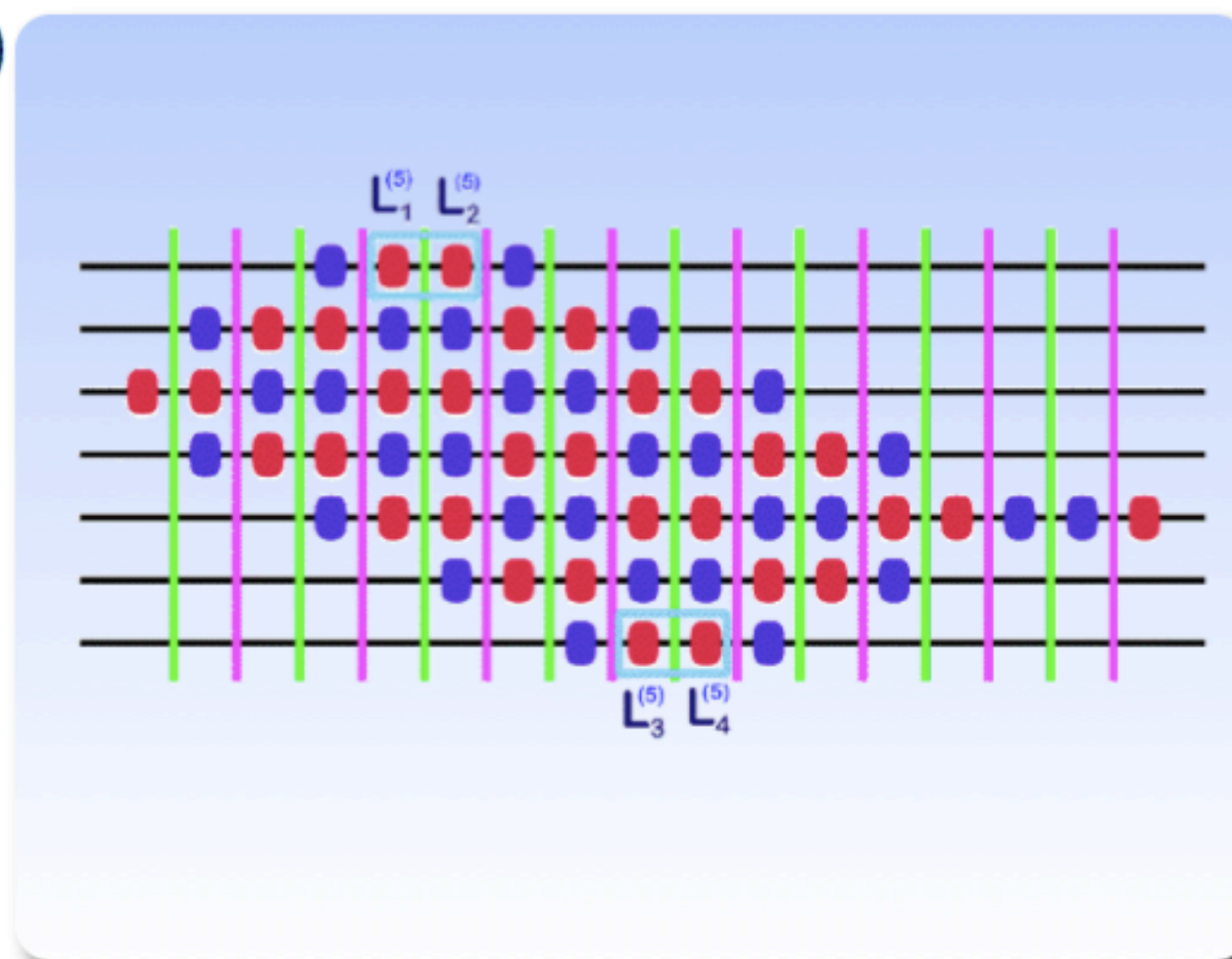

# F&T Scheme

- Wait for qubit pattern to hit an end and then apply op  $R_z^{end}(\theta)$

$$(\overline{H} \cdot \overline{CZ})^2 [a_5|0\rangle_5 + b_5|1\rangle_5] \longrightarrow [a_5\mathbb{I} + b_5\sigma_x^{(3)}\sigma_z^{(4)}\sigma_x^{(5)}\sigma_z^{(6)}\sigma_x^{(7)}]$$

$$\longrightarrow [a_5\mathbb{I} + e^{i\theta}b_5\sigma_x^{(3)}\sigma_z^{(4)}\sigma_x^{(5)}\sigma_z^{(6)}\sigma_x^{(7)}]$$

- Buffer +’s, end patterns have no overlap
- $U^{(a)}(\alpha, \beta, \gamma) \equiv R_z(\alpha)R_y(\beta)R_z(\gamma)$
- 3rd Cycle:

$$R_z(\alpha)R_y(\beta)R_z(\gamma)$$

**Can PIPELINE N 1-qubit gates all in 3 cycles**

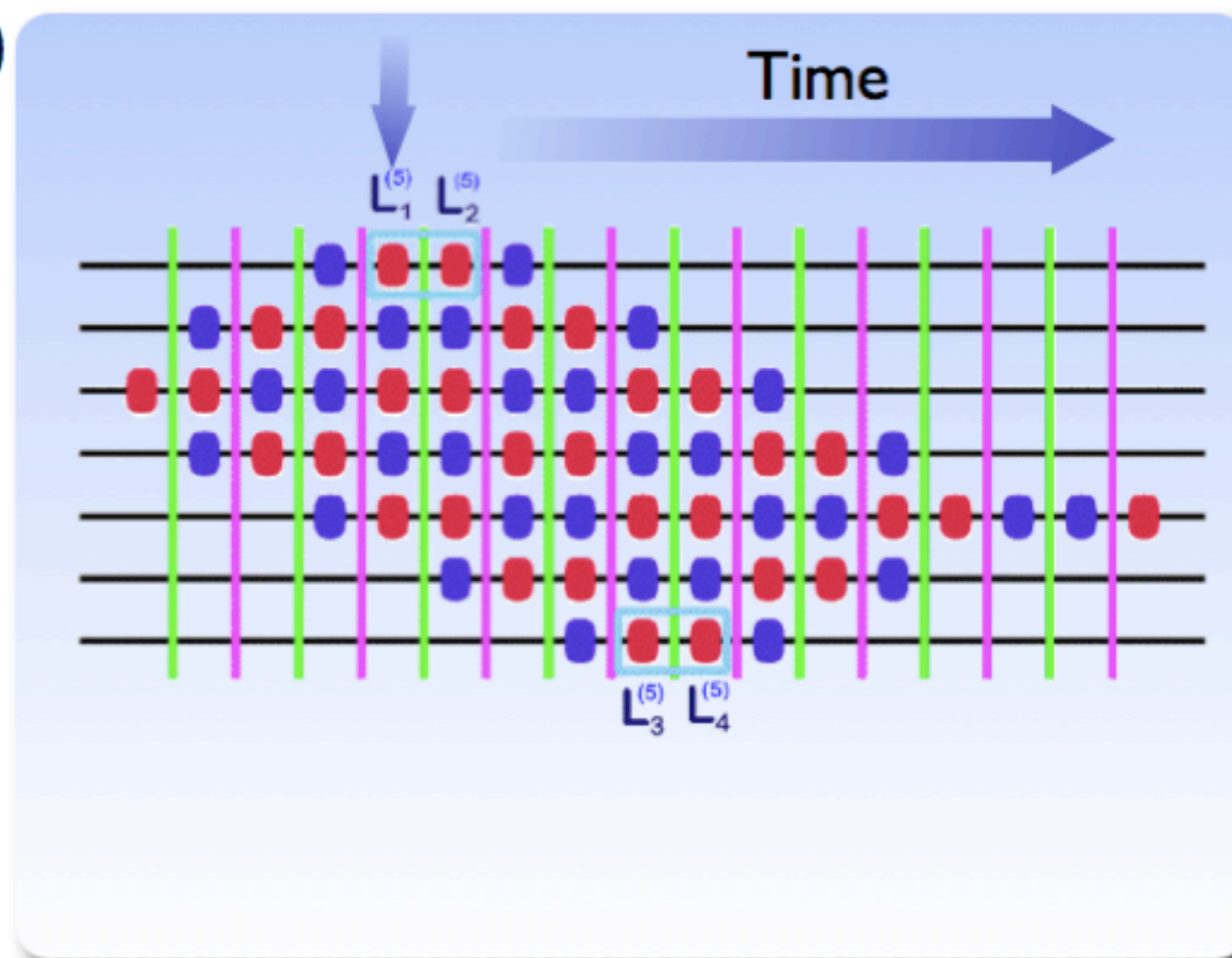

## 2 Qubit Gates?

\* We wait till the control pattern hits an edge and then we use decoupling pulses on the end to trap a part of the control pattern on the edge.

\* We keep this edge trap up and continue applying the global cycling pulses to cycle the other qubits around the free interior until the target pattern impacts the trapped control pattern

\* Then we open the trap for a short time to execute a controlled rotation of the target pattern due to the trapped pattern and then

either reverse everything -  
now have a two qubit gate

or

retrap the control pattern and await for another target pattern to impact the control - multi-target gates in one cycle

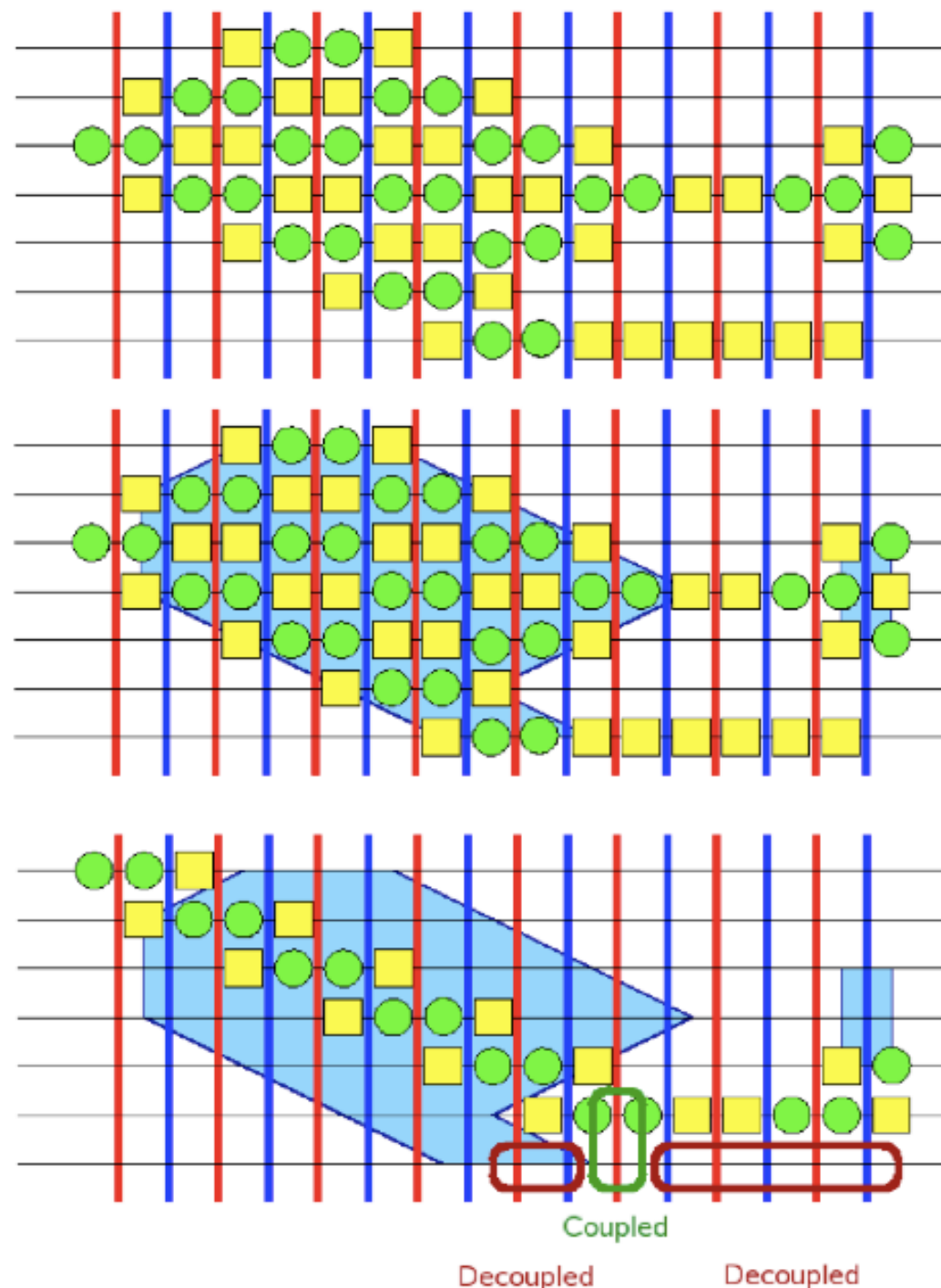

## Algorithms?

Joseph Fitzsimons, Li Xiao, Simon C. Benjamin, Jonathan A. Jones, quant-ph/606118

### Deutsch Algorithm

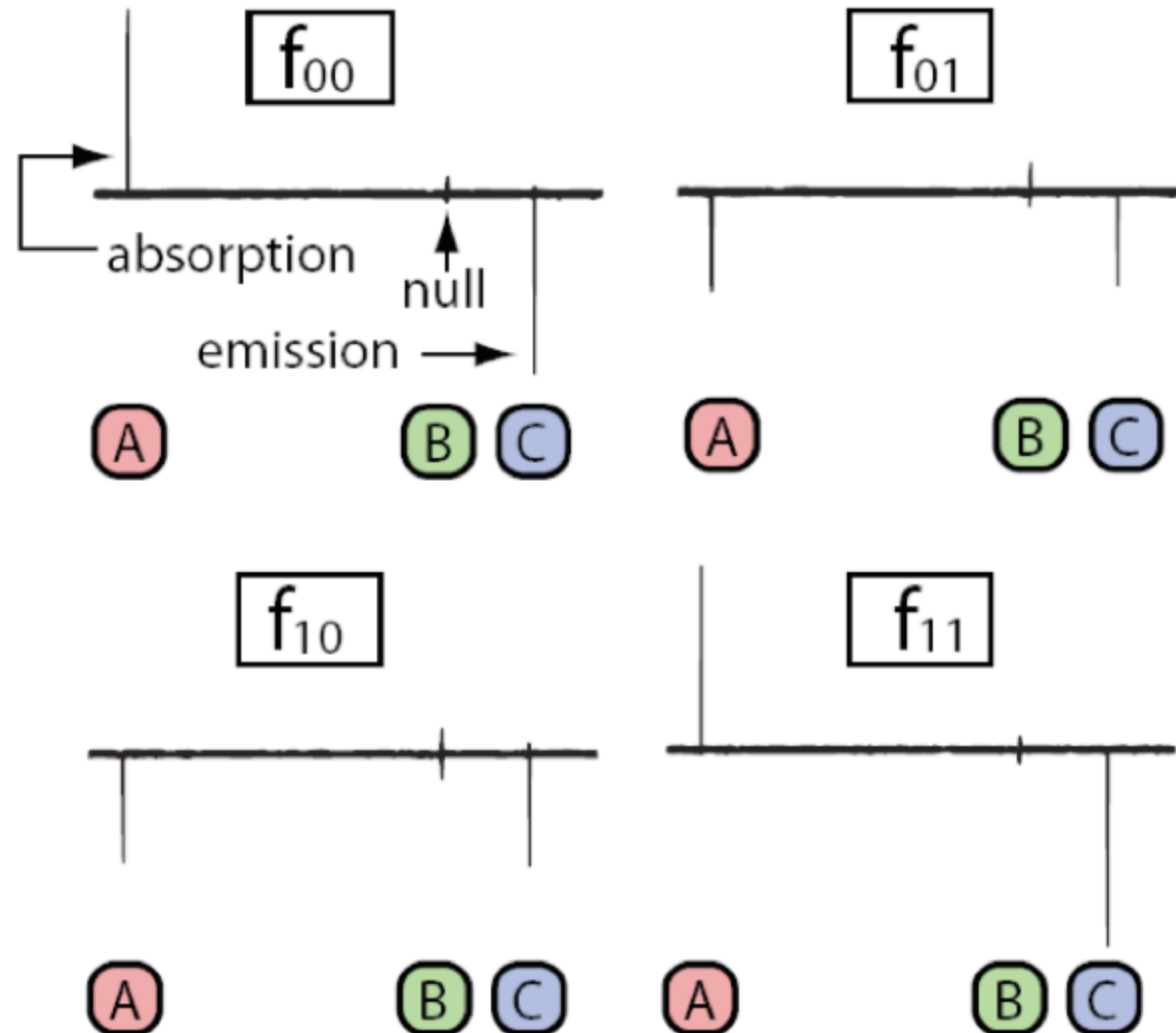
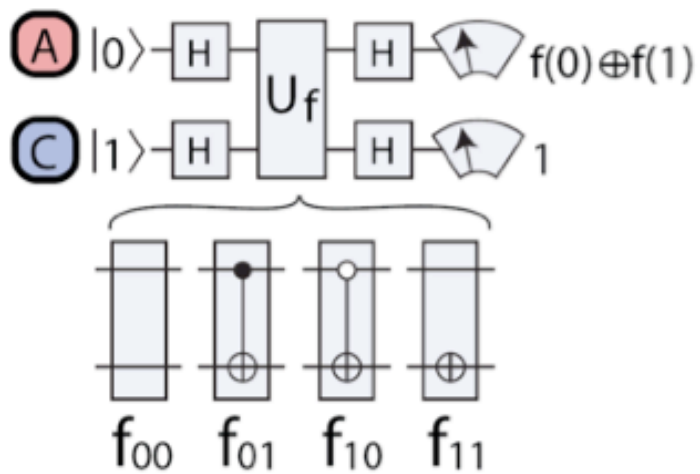



# Conclusions

- Globally controlled Universal QC
  - Could have very large impact in reducing classical control hardware and power dissipation? BUT!
- So far Globally Controlled Fault Tolerant Quantum Error Correction in the literature
- Our design based on 1D nearest neighbor physics, but with some spatial engineering of 1D system,
- More work needed to fully investigate Fault Tolerance and establish existence of threshold

[www.ics.mq.edu.au/qis](http://www.ics.mq.edu.au/qis)

<http://www.qunat.org/personal.php?id=6>

